

FRAME PROFILE

FRAME

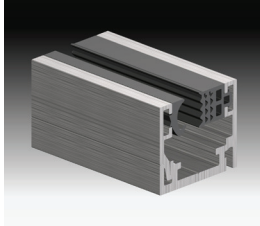

- AL-Frame-D
- AL-Clip-D
- AL-EPDM-8/10/12
- AL-EPDM-16
- AL-EPDM-F



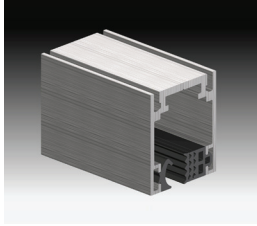





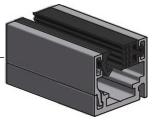

TOP-FRAME

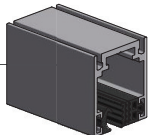
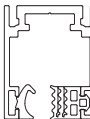
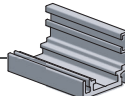

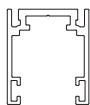
- AL-Top-Frame-D
- AL-EPDM-8/10/12
- AL-EPDM-16
- AL-EPDM-F

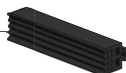
MATERIAL: Profil aus Aluminium, Dichtung TPE
GLASSTÄRKE: Glas-Seitenteile 8-16 mm
OBERFLÄCHE PROFILE: Aluminium eloxiert, Edelstahlleffekt
OBERFLÄCHE GUMMI: Grau, schwarz

Verfügbar in 6 m

Artikel Nr.	Beschreibung		
AL-Frame	Fixrahmenverglasungsprofil für Boden, Wand und Decke (optional)		
AL-Top-Frame	Fixrahmenverglasungsprofil für Decke		
AL-Frame-D	Basisrahmenprofil		
AL-Top-Frame-D	Deckenbasisrahmenprofil		
AL-Clip-D	Clipprofil		
AL-EPDM-8/10/12	Anschlaggummi für 8, 10 und 12 mm Glas		
AL-EPDM-16	Anschlaggummi für 16 mm Glas		
AL-EPDM-F	Fixiergummi		

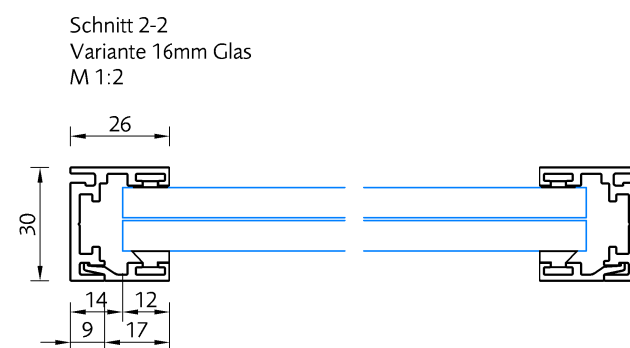
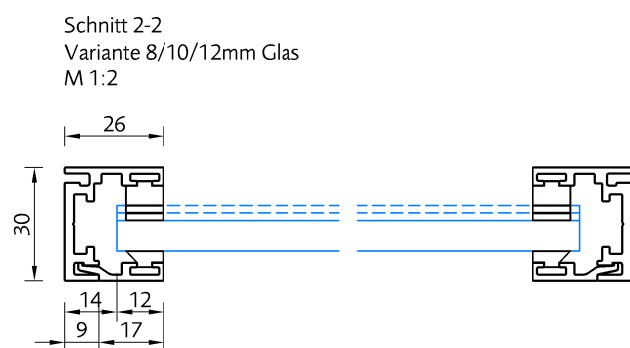
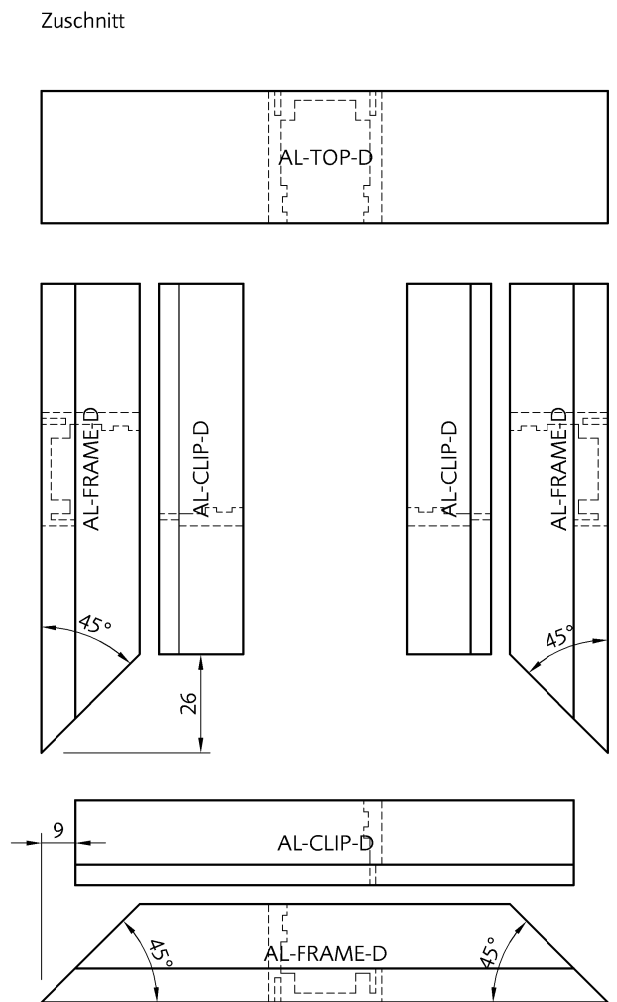
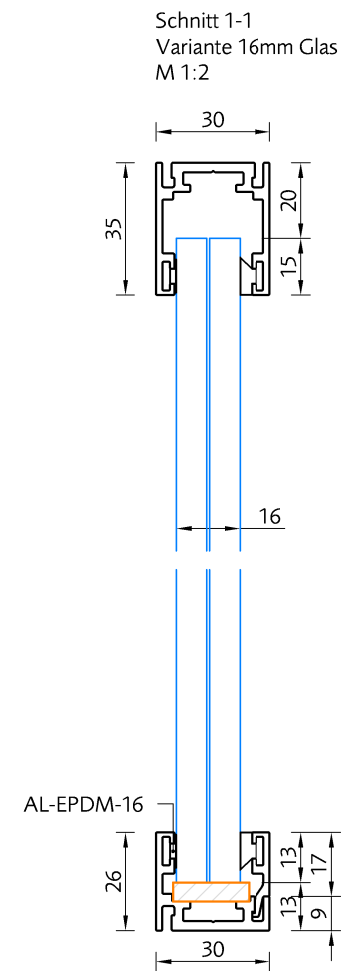
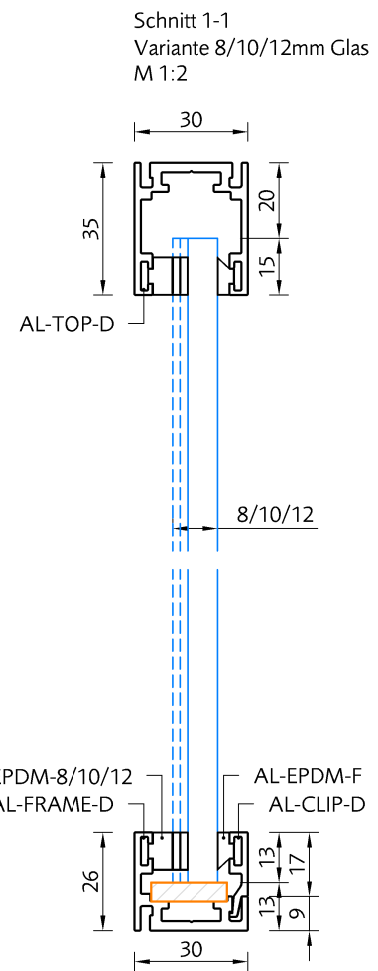
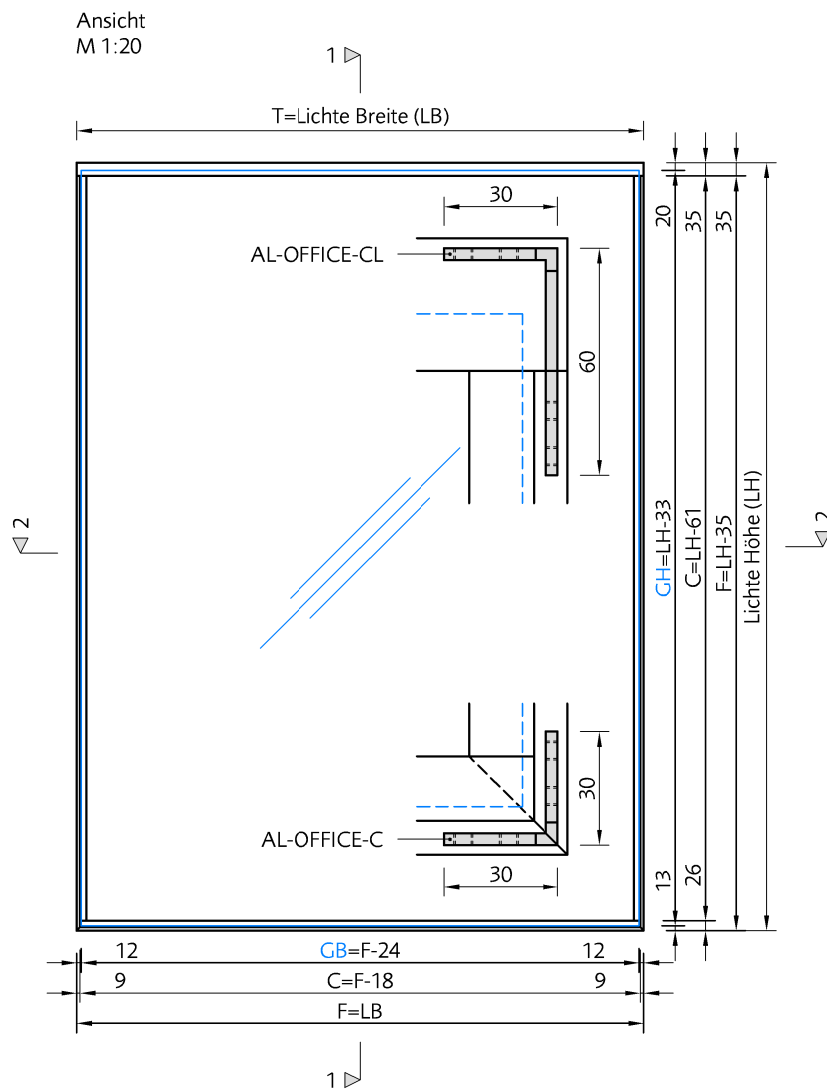

T	Länge AL-TOP-D
F	Länge AL-FRAME-D
C	Länge AL-CLIP-D
GB	Glasbreite
GH	Glashöhe
DB	Durchgangsbreite
DH	Durchgangshöhe

LängleGlas
Befestigungs-Systeme
Glass-Fastening-Systems
www.langleglas.com

Projekt	AL-Office					
Bauherr	FRAME					
Planinhalt						
Gezeichnet	HA	20.11.2014	Massstab	Zeichnungsnummer	Blatt	Index
Geändert	HA	10.03.2016	1:20	703 005	A	
Freigegeben			1:2			